

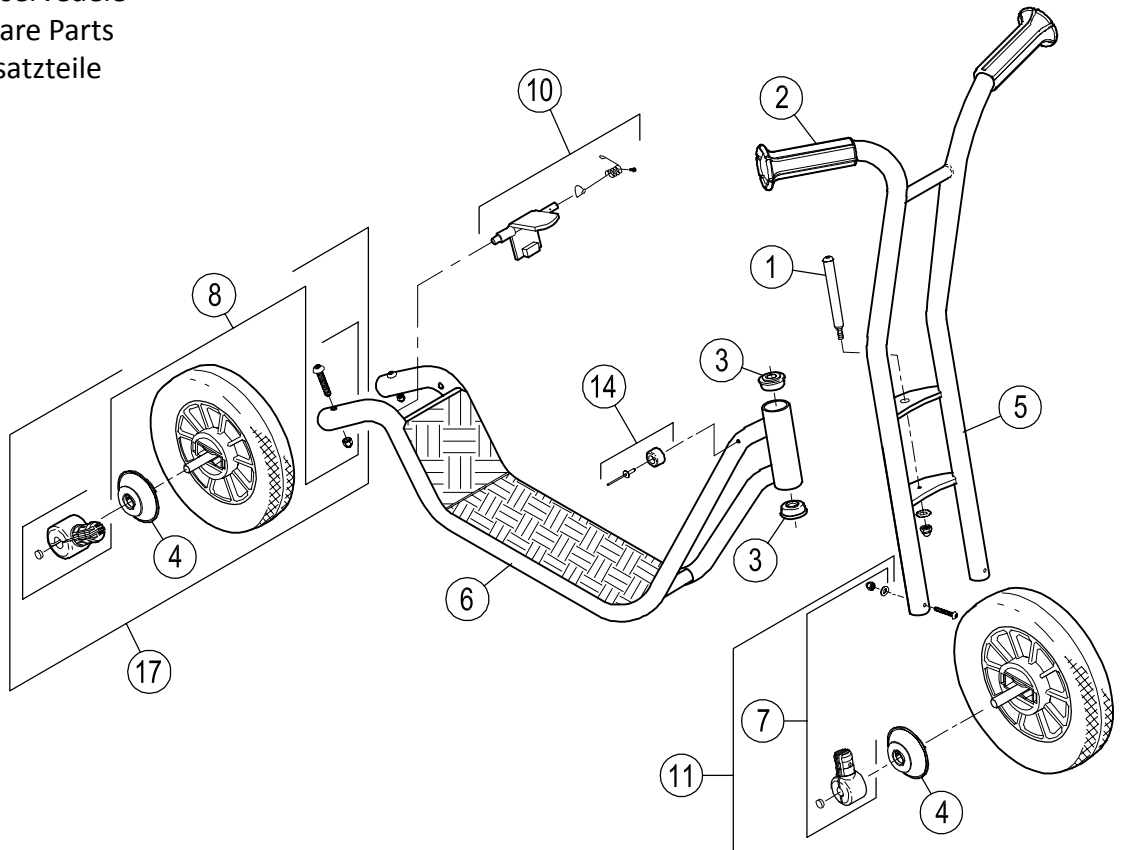

















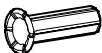











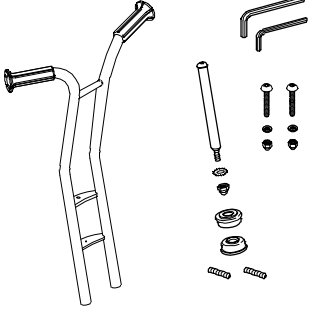



# 467



- DK** Reservedele
- GB** Spare Parts
- DE** Ersatzteile

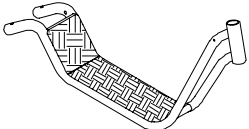

Pos.		Pos.		Pos.	
1	 x1  x2  x1	7	 x2  x2  x2  x2  x1	13	
2	 x2  x2	8	 x2  x2  x2  x1	14	 x2  x2
3	 x2	9		15	
4	 x2	10	 x1  x1  x1	16	
5		11	      	17	    
6		12		18	

# 467



- DK** Reservedele
- GB** Spare Parts
- DE** Ersatzteile

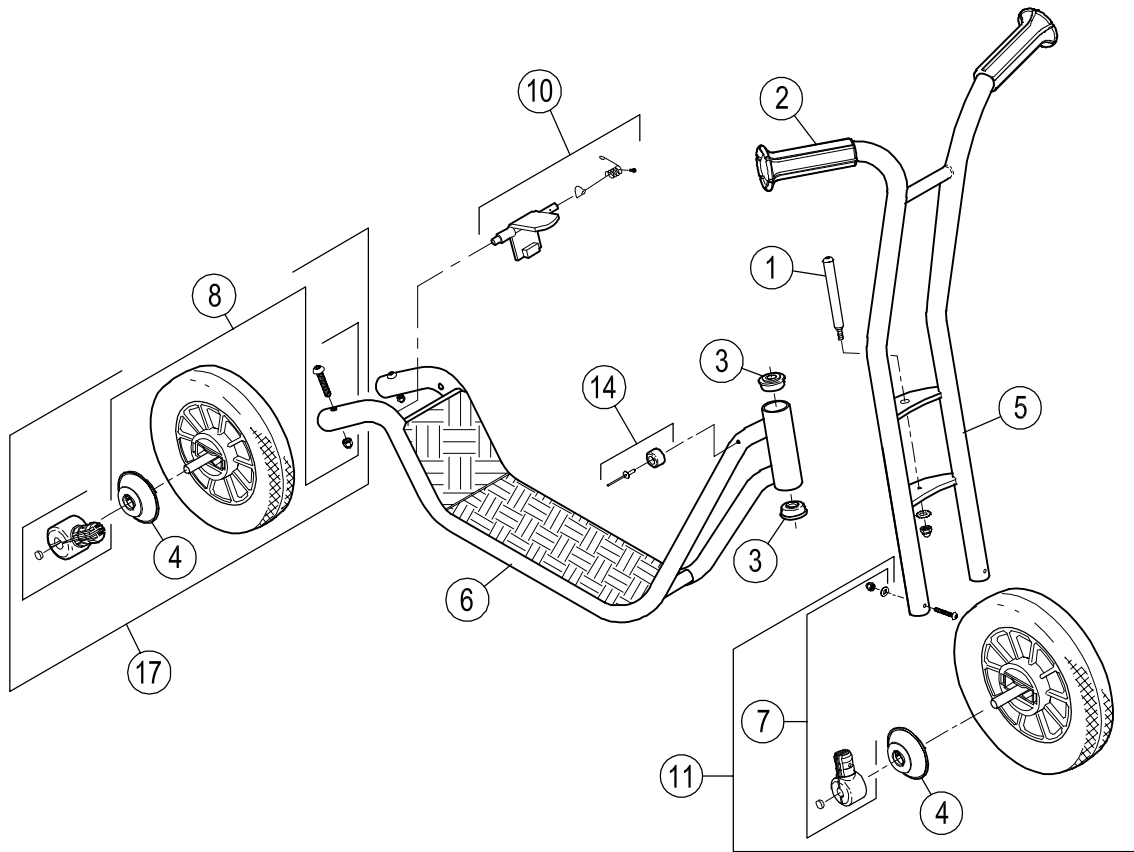

		467.00			
		Version			
Pos.	3.2	3.3			
1	50502	50502			
2	50538	50538			
3	50504	50504			
4	50505	50598			
5	50554	50554			
6	50540	50540			
7	50508	50508			
8	50507	50507			
9	-	-			
10	50547	50547			
11	50563	50563			
12	-	-			
13	-	-			
14	50532	50532			
15	-	-			
16	-	-			
17	50573	50573			
18	-	-			